

Accommodates through 1 1/4" curbstops; Enlarged Base
Accommodates 2" curbstops; 2 1/2" shaft - screw type

6500 SERIES, SCREW TYPE WITH WATER LID

Box (Components)	UPCode 670610	Ship Code	Ext In Inches	Wt	List Price
89-A(12T&12B)	146681	S	15-21	19	47.00
90-B(12T&15B)	146742	S	18-24	21	47.00
90-C(15T&15B)	146803	S	21-27	22	50.00
91-C(15T&21B)	146865	S	24-33	24	55.00
92-C(15T&27B)	146926	S	30-39	26	57.00
92-D(18T&27B)	146988	S	30-42	28	69.00
93-D(18T&33B)	147046	S	36-48	32	79.00
93-E(24T&33B)	147114	S	36-54	37	82.00
94-E(24T&39B)	147183	S	42-60	41	90.00
95-E(30T&39B)	147251	S	41-64	45	100.00
100-E(24T&21Bš Ext)	147312	S	54-72	50	112.00
100-F(30T&21Bš Ext)	147381	S	54-78	53	121.00
101-F(30T&27Bš Ext)	147459	S	60-84	55	122.00

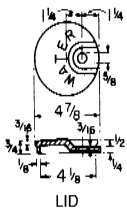

LID

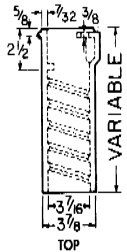

TOP

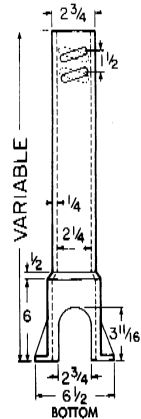

BOTTOM

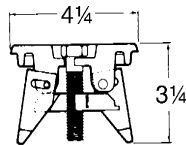

(New Style)
Repair Lid

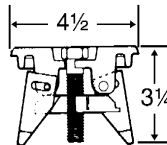

(Old Style)
Repair Lid

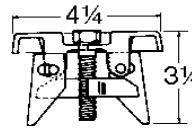
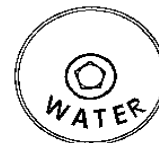

(Outside Cover)
Repair Lid

TOP SECTION WITH WATER LID

Item	UPCode 670610	Ship Code	List Weight	Price
12T	147510	S	12	22.00
15T	147589	S	11	24.00
18T	147640	S	13	31.00
24T	147701	S	18	35.00
30T	147763	S	21	40.00

BOTTOM ONLY

Item	670610 Domestic	Ship Code	List Weight	Price
12B	144670	S	8	19.00
15B	144687	S	9	21.00
21B	144694	S	12	24.00
27B	144700	S	14	25.00
33B	144717	S	18	35.00
39B	144724	S	22	40.00

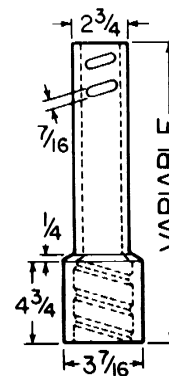

EXTENSION

Item	Height Increase
151	9
152	16
153	28
154	30

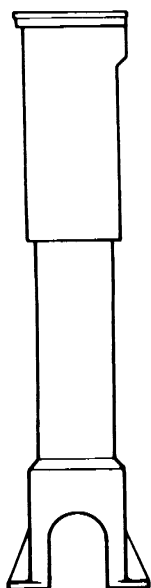

Box Assembled

6500 SERIES PARTS

Item	UPCode 670610	Ship Code	List Weight	Price
151 Ext	144762	S	8.0	21.00
152 Ext	144779	S	12.0	24.00
153 Ext	144786	S	17.0	33.00
154 Ext	144793	S	19.0	36.00
Enlarged Base	144809	S	8.0	22.00
2 1/2" Water Lid	144830	S	1.0	5.00
Brass Screw (Std. WW Pentagon)	144816	S		4.00
Wrench (Std. WW Pentagon)	144908	S	0.5	10.00
2 1/2" Repair Lid Old	144915	S	5.0	30.00
2 1/2" Repair Lid New	144922	S	5.0	30.00
2 1/2" Repair Lid Outside Cover	381518	S	5.0	30.00

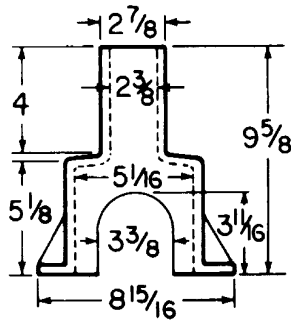

ENLARGED BASE
For 2" Curbstops

Item	Height Increase
6500	6"

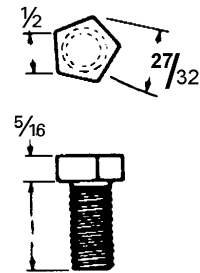
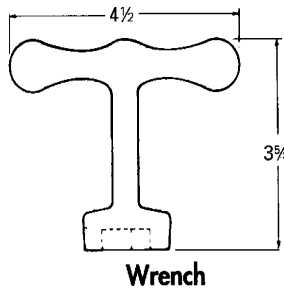

Brass Screw
Std. W W Pentagon

TYLER UNION Valve Boxes are available either pre-assembled or as individual tops and bottoms. For assembled boxes, the UPC codes shown represent a combination of one top and one bottom in the sizes shown. For unassembled boxes, the UPC code represents only a top or a bottom, not a complete box. Therefore, unassembled boxes require ordering tops and bottoms separately.

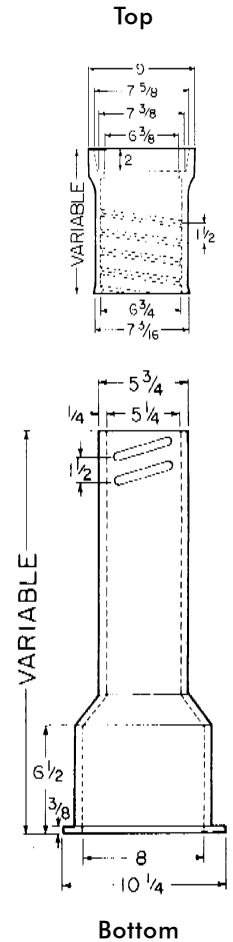

BOXES ASSEMBLED/LESS LIDS

Box (Components)	Assy Height	UPCode	Wt	List Each
562-S(16T-24B)	27-37	145790	71	113.00
563-S(16T+30B)	33-43	145752	78	120.00
564-S(16T+36B)	39-50	145806	85	127.00
662-S(26T+30B)	36-52	145769	93	158.00
664-S(26T+36B)	39-60	145813	100	163.00

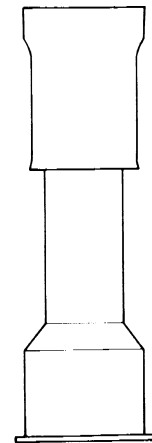

Parts Not Assembled/Less Lids

TOPS
(Less Lids)

Box (Components)	Assy Height	UPCode 670610	Lgt	Wt	List Each
461-S(10T+15B)	19-22	144939	10T	23	31.00
462-S(10T+24B)	27-32	144939	10T	23	31.00
562-S(16T+24B)	27-37	144946	16T	36	49.00
563-S(16T+30B)	33-43	144946	16T	36	49.00
564-S(16T-36B)	39-50	144946	16T	36	49.00
662-S(26T-30B)	36-52	144953	26T	51	69.00
664-S(26T+36B)	39-60	144953	26T	51	69.00
666-S(26T+24B+#60 Ext)	51-71	144953	26T	51	69.00
668-S(26T+36B+#60 Ext)	62-82	144953	26T	51	69.00

BOTTOMS

Box (Components)	Assy Height	UPCode 670610	Lgt	Wt	List Each
461-S(10T+15B)	19-22	145004	15B	27	37.00
462-S(10T+24B)	27-32	145011	24B	35	51.00
562-S(16T+24B)	27-37	145011	24B	35	51.00
563-S(16T+30B)	33-43	144991	30B	42	57.00
564-S(16T-36B)	39-50	145028	36B	49	67.00
662-S(26T-30B)	36-52	144991	30B	42	57.00
664-S(26T+36B)	39-60	145028	36B	49	67.00
666-S(26T+24B+#60 Ext)	51-71	145011	24B	35	51.00
668-S(26T+36B+#60 Ext)	62-82	145028	36B	49	67.00

EXTENSIONS

Item/Description	Height Increase	UPCode 670610	Wt	List Each
#58 Screw-Type	14	145141	29	46.00
#59 Screw-Type	18	145158	33	54.00
#60 Screw-Type	24	145059	36	57.00

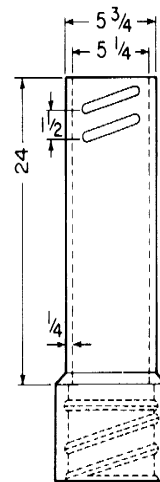
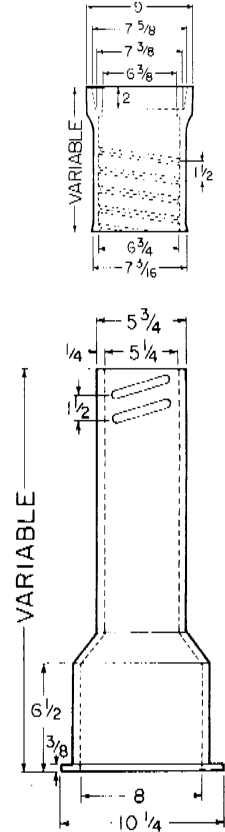

60 Extension

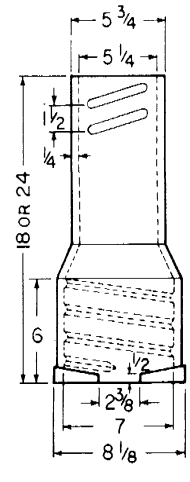

58 & 59 Extension

LIDS & RISERS:
All Lidspage 83
All Riserspage 84

TYLER UNION Valve Boxes are available either pre-assembled or as individual tops and bottoms. For assembled boxes, the UPC codes shown represent a combination of one top and one bottom in the sizes shown. For unassembled boxes, the UPC code represents only a top or a bottom, not a complete box. Therefore, unassembled boxes require ordering tops and bottoms separately.

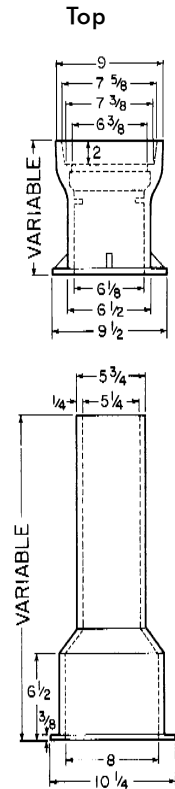

BOXES ASSEMBLED/LESS LIDS

Box (Components)	Extension Height	UPCode 670610	Wt	List Each
562-A(16T-24B)	27-37	145868	72	113.00
563-A(16T+30B)	33-43	145714	81	120.00
564-A(16T+36B)	39-50	145875	83	127.00
662-A(26T+30B)	36-52	145721	97	158.00
664-A(26T+36B)	39-60	145882	99	163.00

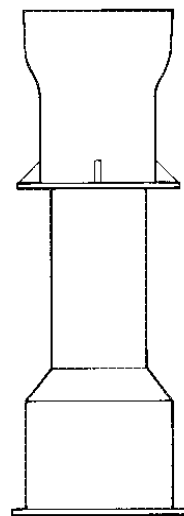

Box Assembled

Lids marked "WATER" will ship unless otherwise specified:
Also available 5 1/4 Drop Lids:
WATER OMA
GAS
SEWER
MWW
(PLAIN)

Parts Not Assembled/Less Lids

TOPS

Box (Components)	Assy Height	UPCode 670610	Lgt	Wt	List Each
461-A(10T+15B)	19-22	144960	10T	29	39.00
462-A(10T+24B)	27-32	144960	10T	29	39.00
562-A(16T+24B)	27-37	144977	16T	36	49.00
563-A(16T+30B)	33-43	144977	16T	36	49.00
564-A(16T-36B)	39-50	144977	16T	36	49.00
662-A(26T-30B)	36-52	144984	26T	52	71.00
664-A(26T+36B)	39-60	144984	26T	52	71.00
666-A(26T+24B+#60-A Ext)	51-71	144984	26T	52	71.00
668-A(26T+36B+#60-A Ext)	62-82	144984	26T	52	71.00

BOTTOMS

Box (Components)	Assy Height	UPCode 670610	Lgt	Wt	List Each
461-A(10T+15B)	19-22	145073	15B	26	36.00
462-A(10T+24B)	27-32	145080	24B	36	51.00
562-A(16T+24B)	27-37	145080	24B	36	51.00
563-A(16T+30B)	33-43	145127	30B	45	61.00
564-A(16T-36B)	39-50	145097	36B	47	65.00
662-A(26T-30B)	36-52	145127	30B	45	61.00
664-A(26T+36B)	39-60	145097	36B	47	65.00
666-A(26T+24B+#60-A Ext)	51-71	145080	24B	35	51.00
668-A(26T+36B+#60-A Ext)	62-82	145097	36B	49	65.00

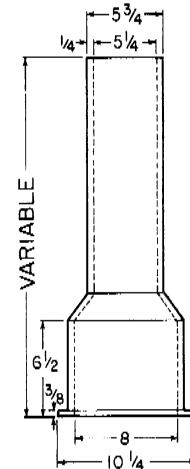
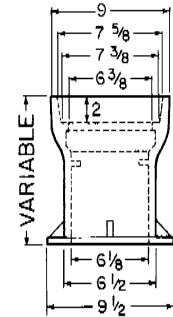

EXTENSIONS

Item/Description	Height Increase	UPCode 670610	Wt	List Each
#58-A Slip-Type	14	145233	29	46.00
#59-A Slip-Type	18	145240	31	54.00
#60-A Slip-Type	24	145066	36	57.00

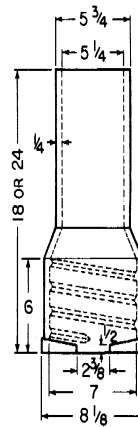

58-A and 59-A Extension

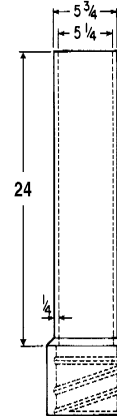

60-A Extension

LIDS & RISERS:
All Lidspage 83
All Riserspage 84

TYLER UNION Valve Boxes are available either pre-assembled or as individual tops and bottoms. For assembled boxes, the UPC codes shown represent a combination of one top and one bottom in the sizes shown. For unassembled boxes, the UPC code represents only a top or a bottom, not a complete box. Therefore, unassembled boxes require ordering tops and bottoms separately.

Top

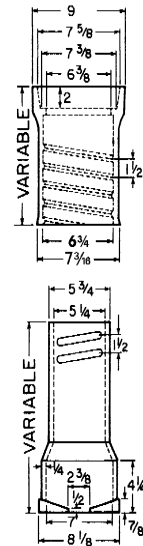

Bottom

Boxes assembled/less bases & lids:

Box (Components)	Extension Height	UPCode 670610	Wt	List Each
B(16T+24B)	39-49	145936	69	113.00
C(16T+30B)	45-54	145943	73	124.00
CC(16T+36B)	51-60	145950	75	130.00
D(26T+30B)	45-66	145967	88	157.00
DD(26T+36B)	51-72	145974	90	168.00

NOTE: Order required lids & bases separately.

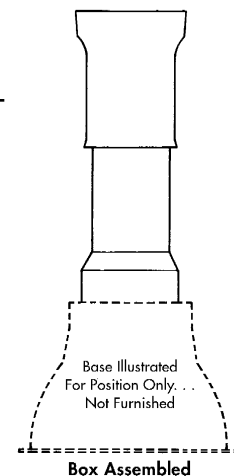

Lids marked "WATER" will ship unless otherwise specified:
Also available 5 1/4 Drop Lids:
WATER OMA
GAS
SEWER
MWW
(PLAIN)

STANDARD & SPECIAL DROP & LOCK LIDS

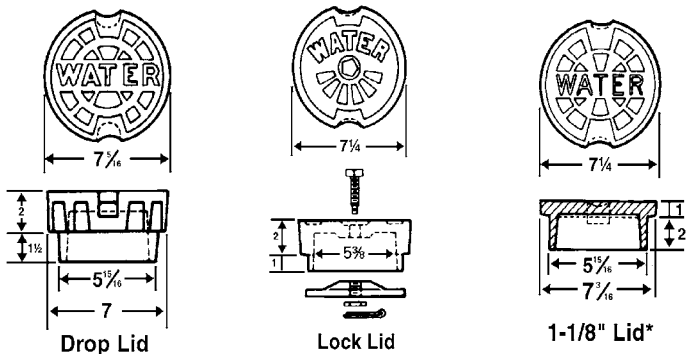

LIDS ("WATER")

Item/Description	UPCode	Wt.	List Price
5 1/4 Drop Lid	145325	12	17.00
5 1/4 Lock Lid	145462	12	29.00
1 1/8 Lid*	145509	12	17.00

*Used with 1 1/8" Riser Only

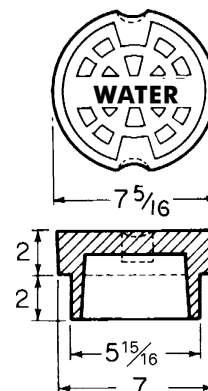

5 1/4" OMA DROP LID

Special Markings	UPCode	Ship Code	List Price
WATER OMA*	145301	N	17.00

*OMA marking is inside lid.

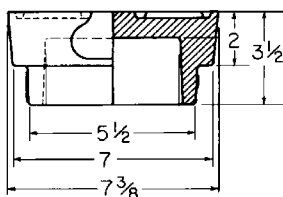

5 1/4" MWW DROP LID

UPCode	Ship Code	Wt.	List Price
670610	N	12	17.00

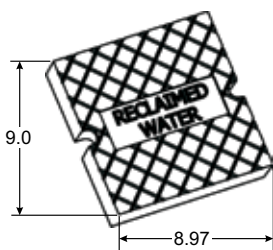

SQUARE RECLAIMED WATER LID

UPCode	Ship Code	Wt.	List Price
670610	N	13	23.00

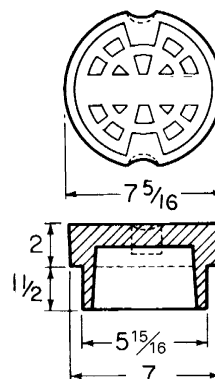

5 1/4" DROP LID W/SPECIAL MARKINGS*

Special Markings	UPCode	Ship Code	Wt.	List Price
GAS	145332	S	12	17.00
SEWER	145349	S	12	17.00
PLAIN	145356	S	12	17.00
REUSE	458975	S	12	22.00

*NOTE: Lids marked with "Water" will be shipped unless otherwise specified.

**#69 SCREW TYPE ADJUSTABLE RISER
FOR 6850/60 SERIES
(Uses Standard Drop Lid)**

Height Increase	UPCode	Ship Code	Wt	List Price
2 1/2"-9"	148197	S	29	48.00

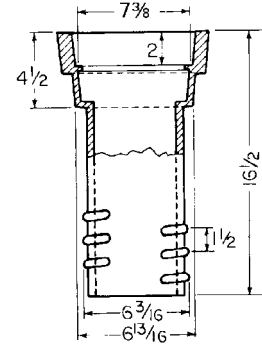

**#69-A SLIP TYPE ADJUSTABLE RISER
FOR 6855 SERIES
(Uses Standard Drop Lid)**

Height Increase	UPCode	Ship Code	Wt	List Price
2 1/2"-12"	148241	S	31	48.00

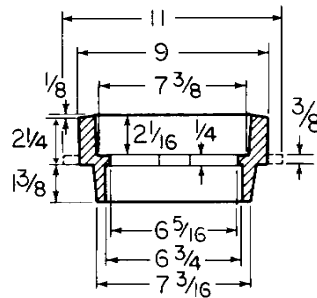
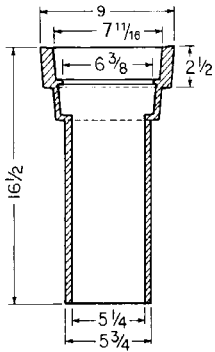

**5 1/4" x 2 1/4" Riser
(Uses Standard 5 1/4"
Drop Lid)**

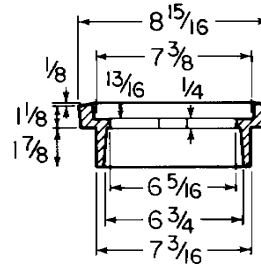

**5 1/4" x 1 1/8" Riser
(Requires 1 1/8" Riser Lid)**

RISERS

Item/Description	UPCode	Height Increase	Wt	List Price
5 1/4 x 1 1/8 Slip-In*	145554	1 1/8"	8	32.00
5 1/4 x 2 1/4 Slip-In	145547	2 1/4"	14	32.00

*Use with 1 1/8" Lid Only.

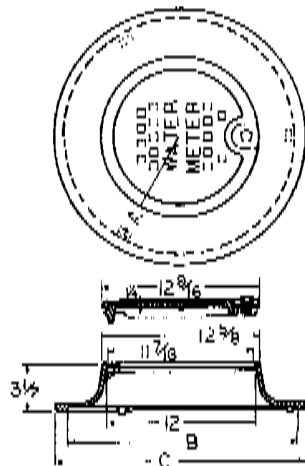

6150 Meter Box Cover

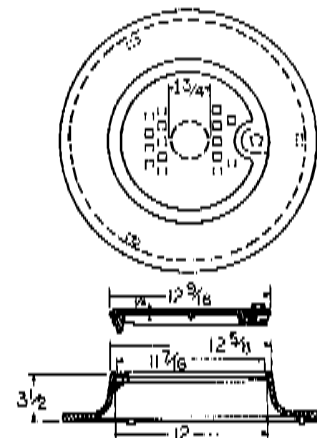

6150TR Meter Cover

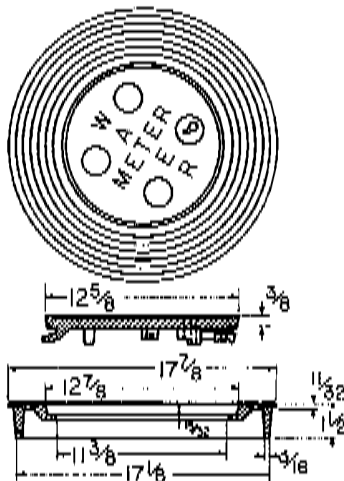

6200 Meter Cover

6150 & 6150TR METER COVERS, CAST IRON

Description	A	B	C
18-in. 6150 Series	8 3/4	18	20
20-in. 6150	9 3/4	20	22

UPCode	Ship Code	Description	Weight	List Price
670610				
148449	S	6150-18 Ring & Lid B/L*	38	67.00
148456	S	6150-18 Ring & Lid B/S*	38	67.00
148647	S	6150-18 Ring Only	27	44.00
148494	S	6150-18/20 Lid With Lock B/L*	11	24.00
148593	S	6150-L-18/20 Lid Less Lock	14	19.00
148500	S	6150-18/20 Lid With Lock B/S*	11	24.00
148463	S	6150-20 Ring & Lid B/L*	37	68.00
148470	S	6150-20 Ring & Lid B/S*	37	68.00
148630	S	6150-R-20 Ring Only	29	45.00
457305	S	910-18 With Lid B/L	56	97.00
457299	S	940-18 With Lid B/S	45	78.00

4572099*B/L = Large Bolts (1"); B/S = Small Bolts (27/32")

6150TR (TOUCH-READER) METER COVERS, CAST IRON

UPCode	Ship Code	Description	Weight	List Price
670610				
148531	S	6150-18 TR Ring & Lid B/L*	41	71.00
148524	S	6150-18 TR Ring & Lid B/S*	41	71.00
148579	S	6150-18/20 TR Lid With Lock B/L*	14	26.00
148562	S	6150-18/20 TR Lid With Lock B/S*	14	26.00
148586	S	6150-18/20 TR Lid Less Lock	12	24.00
148555	S	6150-20 TR Ring & Lid B/L*	40	72.00
148548	S	6150-20 TR Ring & Lid B/S*	40	72.00

*B/L = Large Bolts (1"); B/S = Small Bolts (27/32")

NOTE: 6150TR - Same dimensions as 6150, plus a 1 3/4" access hole in lid.

6200 METER COVER, CAST IRON

UPCode	Ship Code	Description	Weight	List Price
670610				
148708	S	6200 Ring & Lid Less Lock	28	45.00
148760	S	6200-R Ring Only	18	27.00
148739	S	6200-L Lid Less Lock	13	24.00
148722	S	6200-L Lid With Lock	11	27.00

